

INVENTRONICS

RHV-400SxxxSTE

Rev. C

= T{v5 8•» Ô /

C | 4i

- x | ä ä 91%
- x É 9 ÿ ß
- x ... a' y [% Q < » % Q <
- x ¶ • y' y v' k 9' k ? è' k " "
- x ICS ... š š — ‹
- x 9 + 2 <
- x 2 + * 6 P ~
- x U * y ~ 2 - ÿ ß 9
- x v Å ' "



C | 5 é

1 Y æ =

Î Þ Ô 8	Î´ Ô 8 ÿ c d	Î Þ Ô W ÿ	£ Ü Î Þ c d	Ï´ c d	´ d 220Vac	1 Y
24 V	176 ~ 264 Vac	0 ~ 16.7 A	400 W	91.0%	0.96	RHV-400S024STE

I u g h • š 98 220-240 < G lož
 g h W • ÿ µ 98 y < G I k ž < G I ¶ ÿ µ 98 g ! Ô ~ @ f t ' i ¼ ž hož
 g h y i Ú ^ y < G I ž ú g ! Ô ~ @ f t • " hož

Î´ i x

? d	£ 3 š	Å 1 š	£ Ü š	Ô I
ÿ µ 98	176 Vac	-	264 Vac	
ÿ µ È ä 8	47 Hz	-	63 Hz	
¥ v	-	-	0.70 mA	L-FG, 240Vac/60Hz N-FG, 240Vac/60Hz
ÿ µ v	-	-	2.21 A	< G I k ž ú
~ ... v g / Zh	-	-	5.17 A²s	< G I k - è " g Ò Ñ o h k / V Q / W Q Ò ž • # S Y z ! Ô ~ @ f ~ ... v ¼ ž

Ò ¥ 4 i x ? d - š t ... ¶ 5 Š Æ Ò Z é Å 1 š q p i l f c Ø o ž

Î 4i x

?	£ 3 š	À 1 š	£ Ü š	Ô I
ä œ f	0.9	-	-	220-240Vac, 50-60Hz, 60%-100% ç ú (240-400W)
È ´ f â 1	-	-	20%	
È ´ f â 1	-	-	10%	220-240Vac, 50-60Hz, 80%-100% ç ú (320-400W)

Î B4i x

?	£ 3 š	À 1 š	£ Ü š	Ô I
ÿ ß 9 ð †	-2.5%Vo	-	2.5%Vo	ç ú
< U Y K Z U ² 8	-10%Vo	-	10%Vo	
È ÿ ß 9 ¼ f (pk-pk)	-	-	2%Vo	ç ú ó ž " P f ~ 3 . ` k ! Ú ^ k ÿ ß w Ä f, G ` ì y f, † o ž
o ï 9	-	-	5%Vo	ç ú
ç Ä ² ... ä	-	-	±0.5%	ç ú
ç ú ² ... ä	-	-	±0.5%	
• Ñ o ž •	-	-	0.5 s	< G I k ç ú
Á € •	ÿ ß ž [-	5%Vo	ž • ´ ž • y 1 A/µs ç ú y 25% ~ 100% ç ú
	ú 3 ž •	-	10 ms	
" † © f	-	0.03%/ ¢	-	ê " = 0 ¢ ~ Ta Á Ý ›

P á é

?	£ 3 š	À 1 š	£ Ü š	Ô I
ä @220Vac:	89.0%	91.0%	-	ç ú k q ê " z Ô Ñ ž k ä ´ z ³
u ® — { ž ž •	-	228,000 Hours	-	< G I k ê " - k ç ú 3/2 . * (1 ,
. x ž •	-	64,000 Hours	-	< G I k ç ú k q) ê " k i Ô ~ @ f . x ¼ ç
W • ê "	-40 °C	-	+70 °C	~ † y 8 . Z U 8 . z — Ô († ! Ô ~ @ f ´ ì ¼ ç
Á ´ ê "	-40 °C	-	+35 °C	v Á ´ ñ + • Á ´ ê " ~ † y 8 . Z U 8 . z — Ô (†

P á é

¿ d	£ 3 š	À 1 š	£ Ü š	Ô I
¥ " †	-40 °C	-	+85 °C	~ † y 8. Z U 8. z — Ô(†
> * 6 * 2 ~ = ~ . D œ 2 ~ = ~ .		^ ^ ^ ^		
Ô M	-	1060 g	-	

μ Ô Â x Ô

μ ù ç	x Ô
CCC ⁽¹⁾	GB 4943.1
CE	EN 60950-1
+ 3 / x Ô	Ô I
EN 55032/GB 9254 ⁽²⁾	Electromagnetic compatibility of multimedia equipment – Emission Requirements
EN 61000-3-2/GB 17625.1	Harmonic current emissions
EN 61000-3-3	Voltage fluctuations & flicker
EMS x Ô	Ô I
EN 61000-4-2	Electrostatic Discharge (ESD): 8 kV air discharge, 4 kV contact discharge
EN 61000-4-3	Radio-Frequency Electromagnetic Field Susceptibility Test-RS
EN 61000-4-4	Electrical Fast Transient / Burst-EFT
EN 61000-4-5	Surge Immunity Test: AC Power Line: Differential Mode 4 kV, Common Mode 6 kV
EN 61000-4-6	Conducted Radio Frequency Disturbances Test-CS
EN 61000-4-8	Power Frequency Magnetic Field Test
EN 61000-4-11	Voltage Dips
EN 55035	Electromagnetic compatibility of multimedia equipment – Immunity Requirements

I u g h 7 Á - () L k › N 9 • # œ Y a y 3 ½ k H ~ Ú ^ ¶ ... ož
g h › á + 3 / ö Ö k x 9 › • Ä € — Ö © ĩ % ² B ä k ñ È ` Ä € — Ö g + 3 / , ¼ G • ož

· Ž

降额曲线

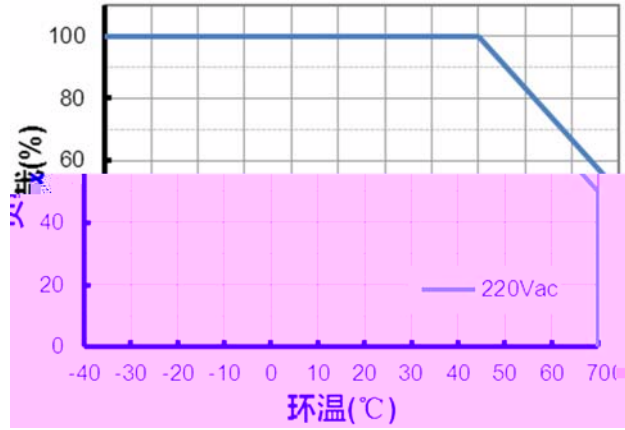

降额曲线

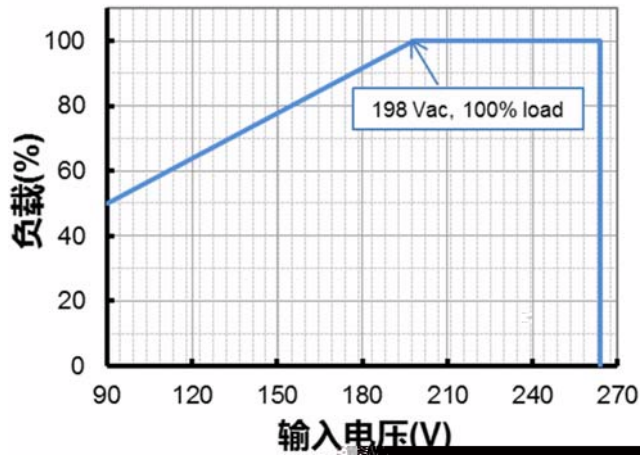

- w * Ò t • Ž

寿命 vs. 环温

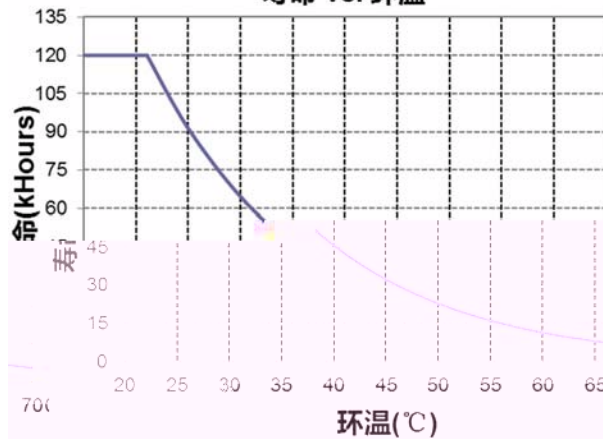

Ò ¥4ix?d-št... q 5ŠĐ Ò ZéÀ's q πilfcØ az

_f•Ž

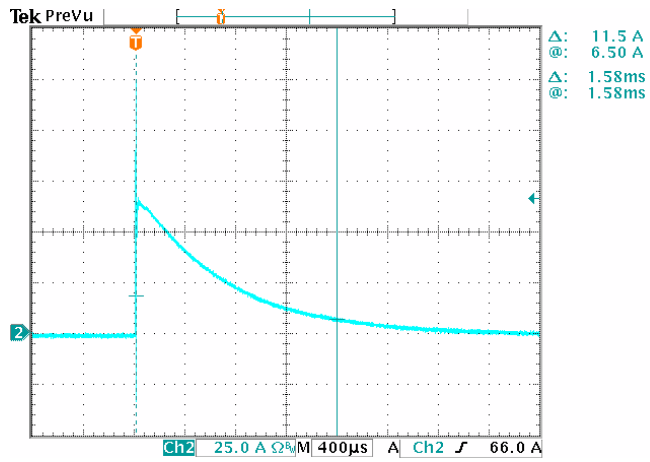

]´•Ž

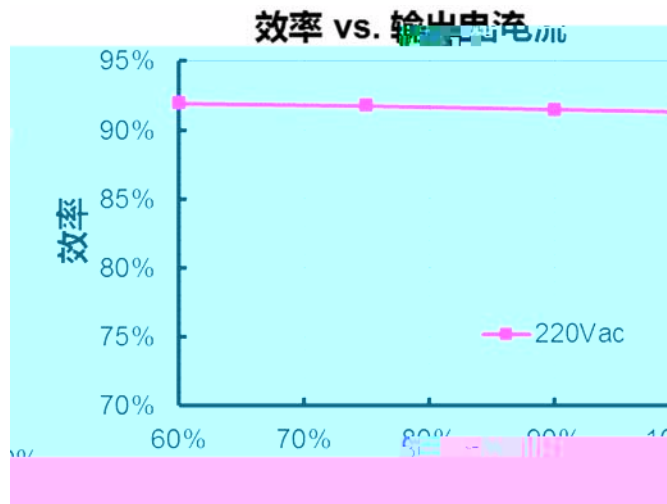

´d•Ž

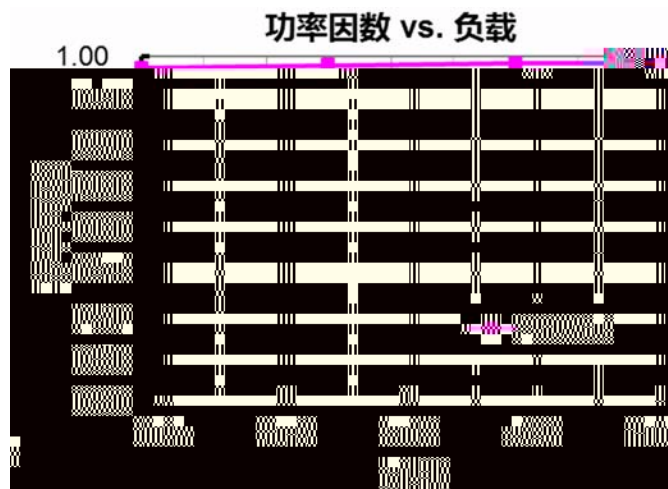

5 f G á • Ž

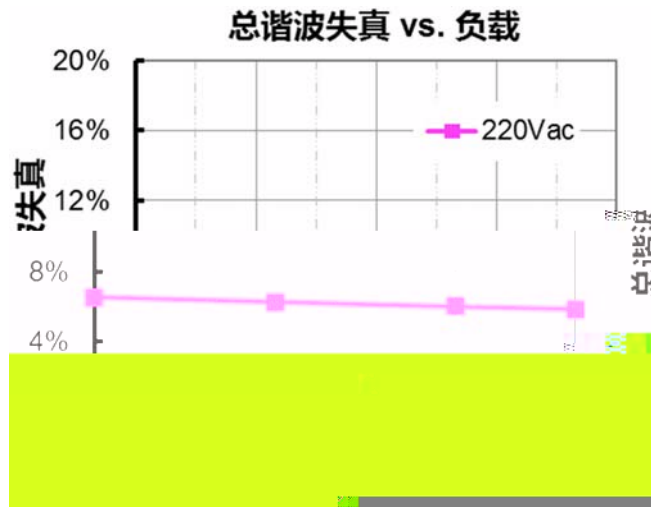

• ō x

?	Ô I
v'	Ê Ö % "ož É v' ò k { ž L " ž k Ê Öž
g'	ÿ ß 9 k' ò " • 8 Äož
? è'	Ê Ö % "ož ? è ž k D } — C oož ? è L " ž k U Ê Öž
" "	Ê Ö % "ož " † " ž k U Ê Ö 3 oož

INVENTRONICS

RHV-400SxxxSTE

Rev. C

= T{v5 8•» Ô /

2 Å ç

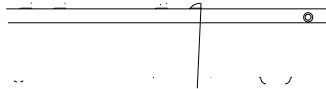
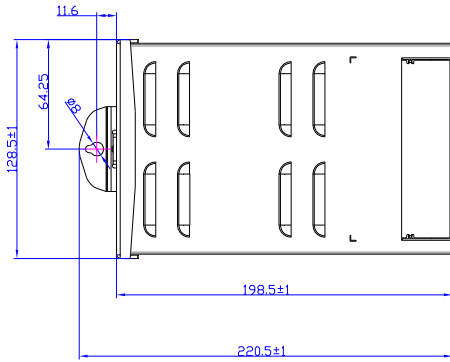

INVENTRONICS

RHV-400SxxxSTE

Rev. C

= T{v5 8•» Ô /

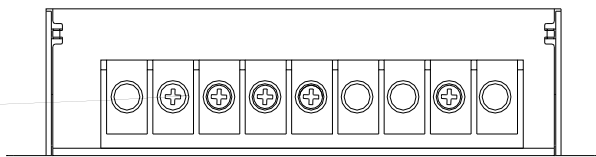
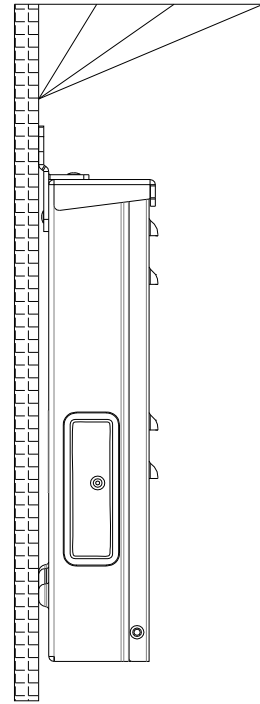
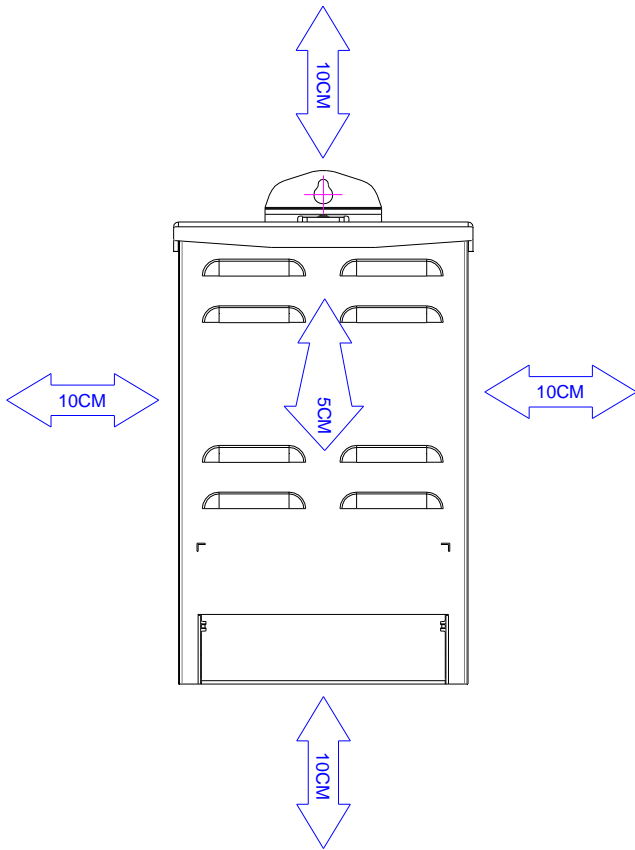

' [b ç

' X • N	• -	' X 5 é		
		• ù	Q	è
2020-05-09	A	G g		
2020-05-14	B	x ^a ç		³ / ₄ •
2021-09-09	C	D } Ô Å		³ / ₄ •
		~ ... v g / ² Z h		³ / ₄ •
		~ ... ¹ / ₄ ç		³ / ₄ •